

Bright 315h



Wi-Fi module



Double sealing
standard feature



Vacuum pack more
products at the
same time



The maximum of functions and reliability

Exclusive vacuum packing machines with "Power-Steel" vacuum chamber, double resistance, gas injection system, absolute vacuum sensor and "Easy" system for the best external vacuum level. Bright 315h guarantees a perfect and long lasting vacuum thanks to the high sealing pressure which ensures an unsurpassed seal.

Bright 315h is ideal for:



Restaurants



Hotel



Catering



Butcher shops



Cheese factory



Food processing
laboratories

Packing methods



Sealing only



Vacuum



External vacuum



MAP

Chef and Jars programs included



Meats



Chicken and
poultry



Fish



Solids/Fillings



Sauces



Dense sauces



Marination



Bakery products



Vegetables



Powders and
spices



Dessert



Pastry bases



"No Stop"
programs



Jars sensor



Jars MIN



Jars MED



Jars MAX









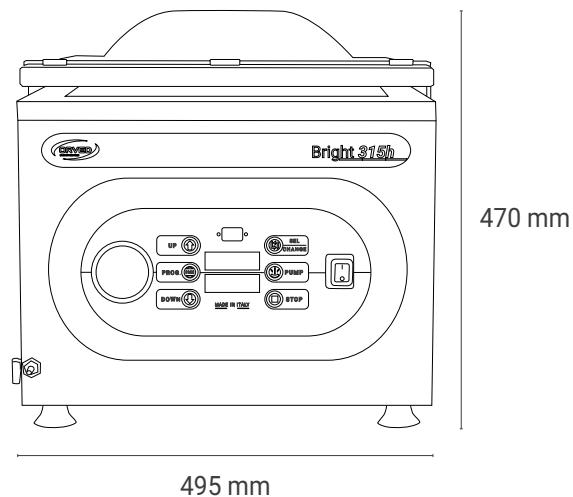

Jars extreme

Technical data

- > Bodywork: stainless steel
- > Size: 495x430x470h mm
- > Chamber size: 350x335x100/190h mm
- > Weight: 43 kg
- > Power grid voltage: 220-240V 50/60Hz
- > Max power absorption: 450 W
- > Sealing bars: 315 mm
- > Vacuum pump: 8 mc/h
- > Max bag size: 300x350 mm



Standard equipment

- | | | |
|--|---|--|
|  Digital panel, 48 programs |  Inert gas supply system |  Nozzle for jars |
|  Absolute vacuum sensor |  Easy accessory included |  USB port for firmware update |
|  Double resistance |  H2out pump dehumidification program |  Counter-bar detachable |

Optional on request

- | | | | |
|---|--|--|--|
|  Cut of seal |  Data stamp |  Wi-Fi Module |  Set of vacuum bags Basic |
|---|--|--|--|

Matching accessories

