

Bright 315



Modulo Wi-Fi



Doppia saldatura di serie



Confeziona più prodotti contemporaneamente



Il massimo per funzioni ed affidabilità

Esclusiva confezionatrice con camera a vuoto "Power Steel", sistema sensoriale di vuoto assoluto e accessorio "Easy" per il massimo vuoto anche in esterno con buste goffrate. Bright 315 garantisce un vuoto perfetto ma soprattutto duraturo nel tempo grazie all'alta pressione di saldatura che assicura una sigillatura ed una tenuta insuperabili.

Bright 315 è ideale per:



Ristoranti



Hotel



Catering



Macellerie



Caseifici



Laboratori alimentari

Metodi di confezionamento



Solo sigillatura



Vuoto



Vuoto esterno



ATM

Programmi Chef e Vasi inclusi



Carni



Pollo



Pesce



Solidi



Sughi



Salse dense



Marinate



Prodotti da forno



Verdure



Polveri e spezie



Dolci



Creeme base pasticceria



No stop



Vasi sensor



Vasi MIN



Vasi MED



Vasi MAX









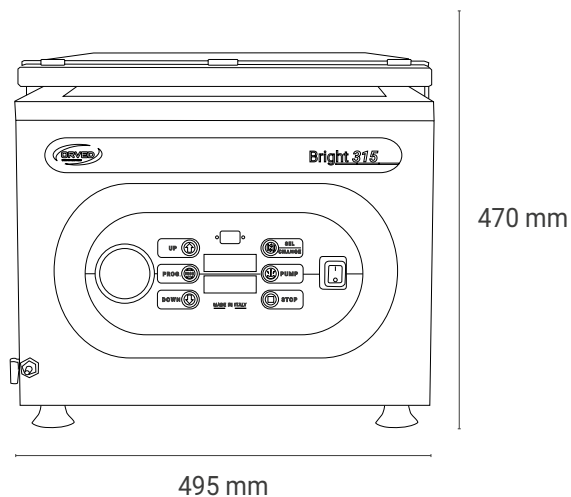

Vasi extreme

Caratteristiche tecniche

- > Carrozzeria: acciaio inox
- > Dimensioni: 495x370x470h mm
- > Dimensioni camera a vuoto: 350x335x100/130h mm
- > Peso: 41,5 kg
- > Tensione: 220-240V 50/60Hz
- > Potenza max assorbita: 450 W
- > Barre saldanti: 315 mm
- > Pompa di vuoto: 8 mc/h
- > Dimensione max busta: 300x350 mm



Dotazioni di serie

- | | | |
|--|---|--|
|  Pannello digitale 48 programmi |  Accessorio easy incluso |  Porta USB per aggiornamento firmware |
|  Sistema sensoriale di vuoto assoluto |  H2out, ciclo deumidificazione pompa |  Controbarra sganciabile |
|  Doppia resistenza |  Ugello per contenitori | |

Optional su richiesta

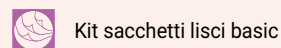
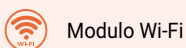

Accessori abbinabili



Sacchetti sottovuoto lisci



Sacchetti sottovuoto gofrati



Sacchetti sottovuoto per cottura



Carrello



Contenitori Conserbox



Easy per vuoto esterno

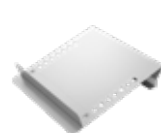

Ripiani inclinati per liquidi