

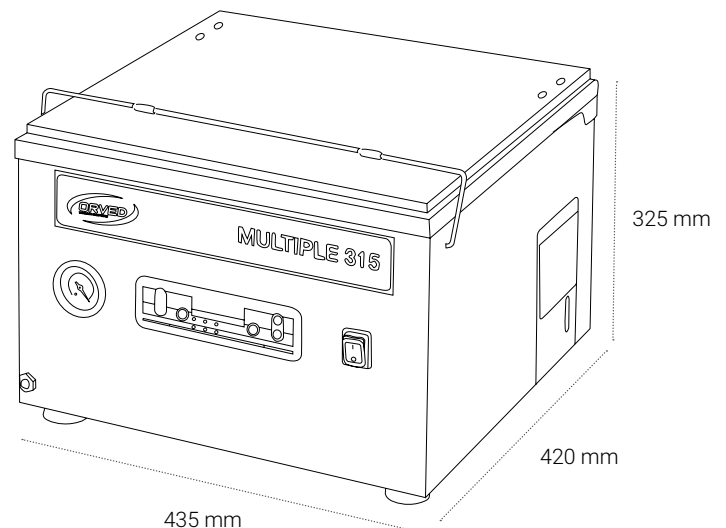

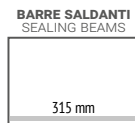



MULTIPLE 315

- > Carrozzeria **Bodywork**: acciaio inox - stainless steel
- > Dimensioni **Size**: 435x420x325h mm
- > Dimensioni camera a vuoto **Chamber size**: 330x335x100/130h mm
- > Peso **Weight**: 32-36 kg
- > Tensione **Power grid voltage**: 230V - 50/60Hz
- > Potenza max assorbita **Max power absorption**: 350-450 W
- > Pompa di vuoto **Vacuum pump**: 4 m³/h - 8 m³/h
- > Dimensione max busta **Max bag size**: 300x350 mm

- > Carrosserie **Carrocería**: acier inoxydable - acero inoxidable
- > Dimensions **Medidas**: 435x420x325h mm
- > Chambre à vide **Cámara de vacío**: 330x335x100/130h mm
- > Poids **Peso**: 32-36 kg
- > Voltage **Tensión**: 230V - 50/60Hz
- > Puissance max absorbée **Potencia máx**: 350-450 W
- > Pompe à vide **Bomba de vacío**: 4 m³/h - 8 m³/h
- > Dimension max du sac **Tamaño máx de bolsa**: 300x350 mm



-  **Pompa opzionale**
Optional vacuum pump - Option pompe - Bomba extra
-  **Ugello per contenitori**
Nozzle for jars - Embout pour récipients - Boquilla para contenedores externos
-  **Easy, creazione vuoto esterno**
Easy for external vacuum - Easy, création du sous vide externe - Easy, para la creación del vacío externo
-  **H2out, ciclo deumidificazione pompa** H2out pump dehumidification program
H2out, cycle de déshumidification de la pompe - H2out programa de deshumidificación de bomba
-  **Kit buste Basic**
Set of vacuum bags Basic - Kit sacs Basic - Kit bolsas Basic